

## LAURENS SPIRALIX tripple, RAO3 32/92

na stěnu | Wandvariante | wall-version

**Indikace výkonu | Indikative Leistung | indicative output  $\Delta t$  50°C**  
**420 ~ 3270 Watt**  
(dle rozměrů radiátoru | je nach Abmessung | according size of radiator)

Všechny rozměry v MM | alle Abmessungen n MM | all dimensions in MM

L...délka otopného tělesa | Heizkörperlänge | length of radiator

hladké trubky (bez vinutí) na dotaz | glatte Rohre (ohne Windung) auf Anfrage | tubes without winding on request

 Jen topení, (uzavřený) topný systém (voda nebo pára)  
Nur Heizung, (geschlossenes) Heizsystem (Wasser oder Dampf)  
Heating only, (closed) heating system (water or steam)

 Kombinovaný provoz | Topení + elektrický  
Kombi-Betrieb | Wasser + Elektrisch  
Combined system | Water + electric heating

 Jen elektrický provoz (na dotaz)  
Rein elektrisch (auf Anfrage)  
Electric version only (on request)

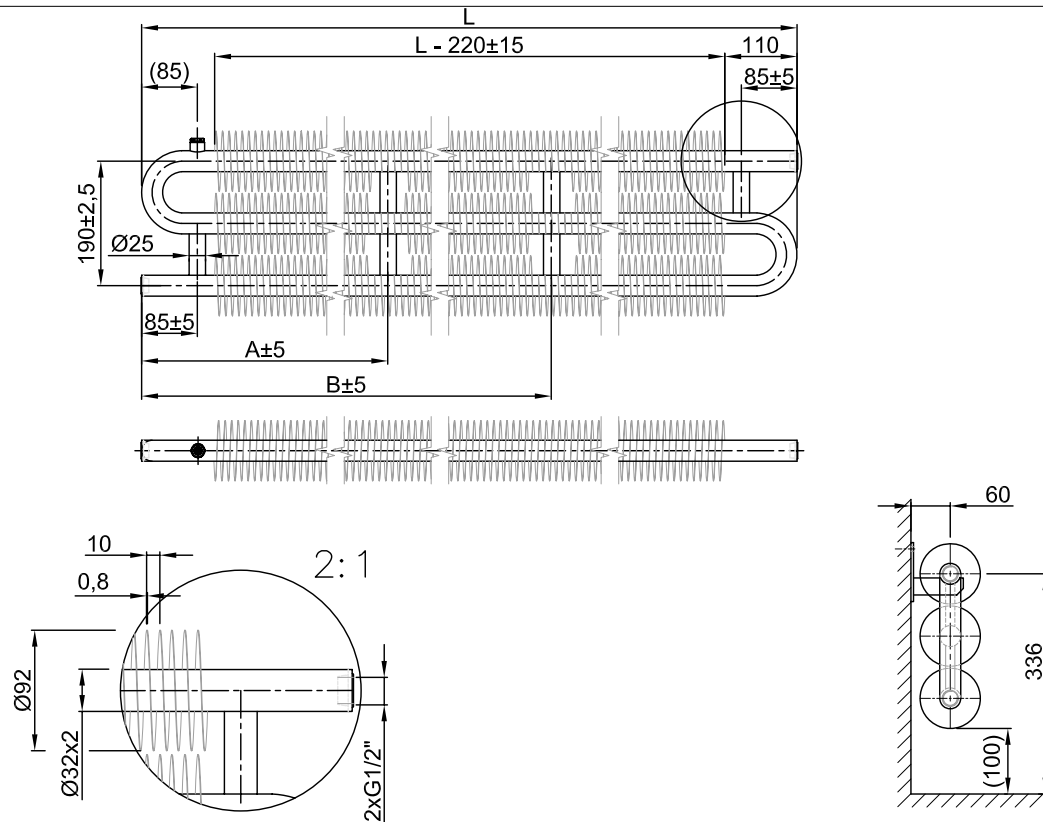
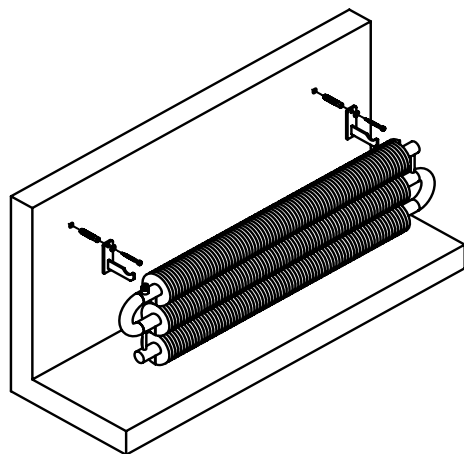



RAO3 32x2x92 ON WALL

 **Ocel | Stahl | steel**  
Vinutí | Windung | finning  
32/92, 56/137, 76/156mm

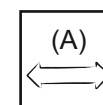
 **Parametry | Tech.Daten | data**  
max. 10 bar  
max. 120° C

 **Délky | Längen | lengths**  
500 - 3000  
po | nach | each 100mm

 **Povrch | Oberfläche | surface**  
9010 RAL bílá | weiss | white  
+% ostatní | andere | other RAL

 **Vertikál | Vertikal | vertical**  
Spiralix Vertical  
na dotaz | auf Anfrage | on request

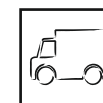

 **Dodání | Lieferung | Delivery**  
4 - 6 týdnů | Wochen | weeks

# LAURENS SPIRALIX tripple, RAO3 32/92

na zem | Fussbonenvariante | floor version

**Indikace výkonu | Indikative Leistung | indicative output  $\Delta t 50^\circ\text{C}$**   
**420 ~ 3270 Watt**  
(dle rozměrů radiátoru | je nach Abmessung | according size of radiator)

Všechny rozměry v MM | alle Abmessungen n MM | all dimensions in MM  
**L...délka otopného tělesa | Heizkörperlänge | length of radiator**  
**hladké trubky (bez vinutí) na dotaz | glatte Rohre (ohne Windung) auf Anfrage | tubes without winding on request**

-  Jen topení, (uzavřený) topný systém (voda nebo pára)  
Nur Heizung, (geschlossenes) Heizsystem (Wasser oder Dampf)  
Heating only, (closed) heating system (water or steam)
-  Kombinovaný provoz | Topení + elektrický  
Kombi-Betrieb | Wasser + Elektrisch  
Combined system | Water + electric heating
-  Jen elektrický provoz (na dotaz)  
Rein elektrisch (auf Anfrage)  
Electric version only (on request)

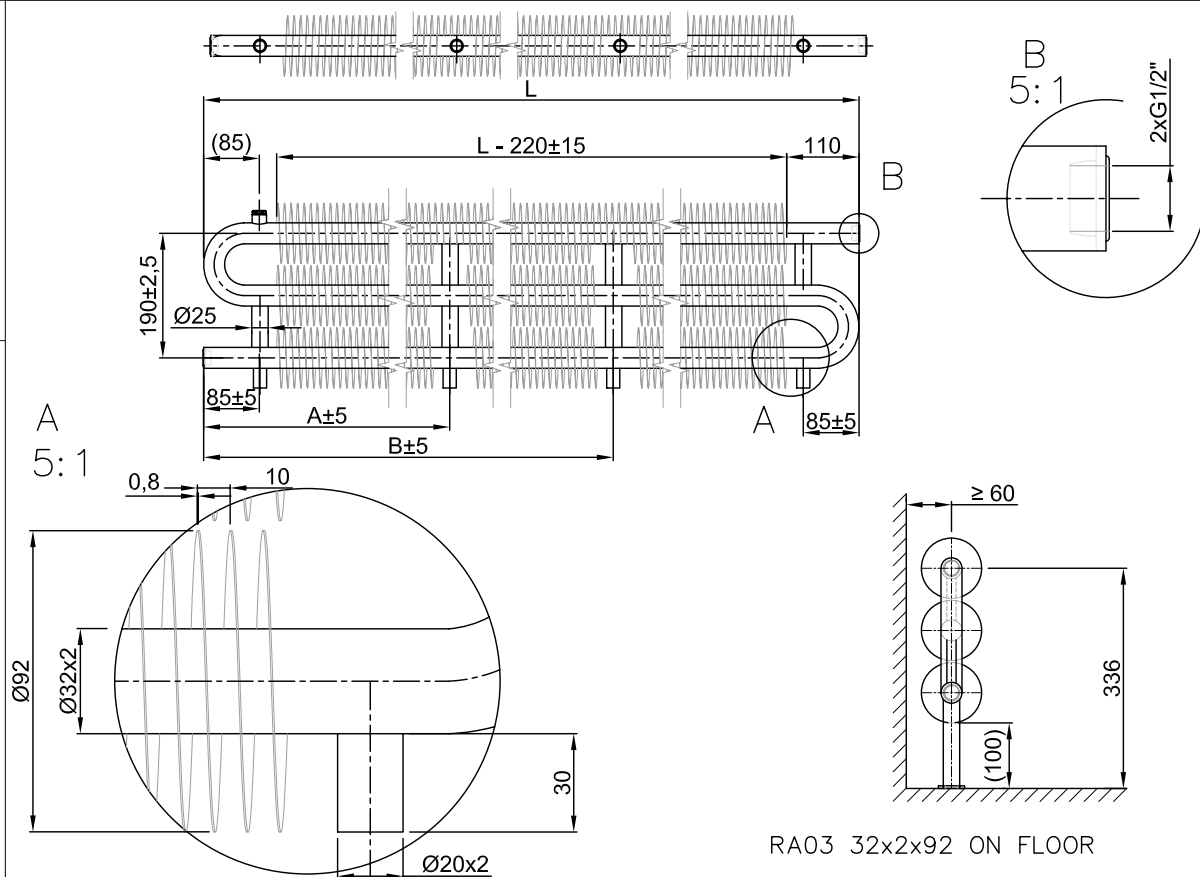
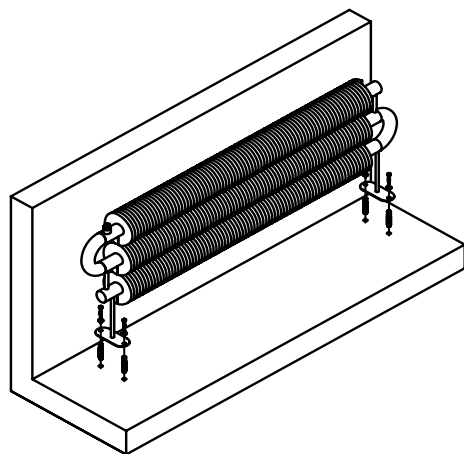



RAO3 32x2x92 ON FLOOR

 **Ocel | Stahl | steel**  
Vinutí | Windung | finning  
32/92, 56/137, 76/156mm

 **Povrch | Oberfläche | surface**  
9010 RAL bílá | weiss | white  
+% ostatní | andere | other RAL

 **Parametry | Tech.Daten | data**  
max. 10 bar  
max. 120° C

 **Vertikál | Vertikal | vertical**  
Spiralix Vertical  
na dotaz | auf Anfrage | on request

 **Délky | Längen | lengths**  
500 - 3000  
po | nach | each 100mm



 **Dodání | Lieferung | Delivery**  
4 - 6 týdnů | Wochen | weeks

# LAURENS SPIRALIX tripple, RAO3 57/137

na stěnu | Wandvariante | wall-version

**Indikace výkonu | Indikative Leistung | indicative output  $\Delta t$  50°C**  
**460 ~ 8240 Watt**  
(dle rozměrů radiátoru | je nach Abmessung | according size of radiator)

Všechny rozměry v MM | alle Abmessungen n MM | all dimensions in MM  
**L...délka otopného tělesa | Heizkörperlänge | length of radiator**  
**hladké trubky (bez vinutí) na dotaz | glatte Rohre (ohne Windung) auf Anfrage | tubes without winding on request**

-  Jen topení, (uzavřený) topný systém (voda nebo pára)  
Nur Heizung, (geschlossenes) Heizsystem (Wasser oder Dampf)  
Heating only, (closed) heating system (water or steam)
-  Kombinovaný provoz | Topení + elektrický  
Kombi-Betrieb | Wasser + Elektrisch  
Combined system | Water + electric heating
-  Jen elektrický provoz (na dotaz)  
Rein elektrisch (auf Anfrage)  
Electric version only (on request)

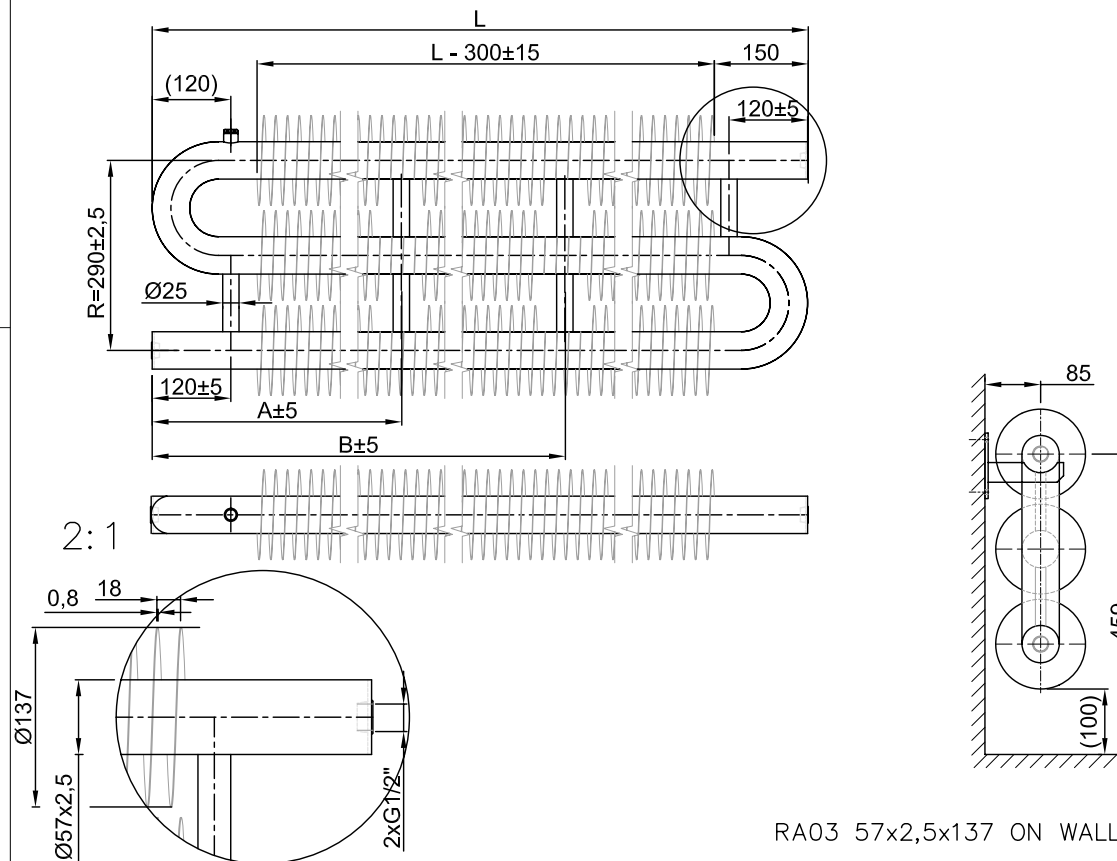
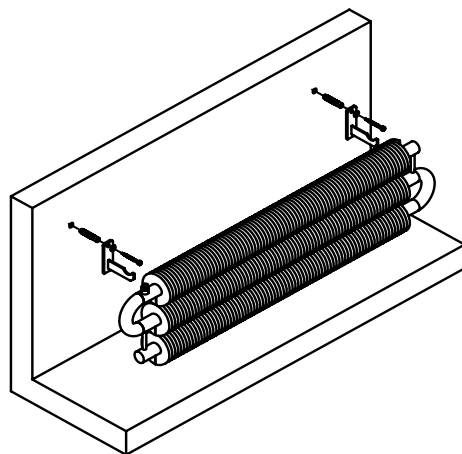

RAO3 57x2,5x137 ON WALL

 **Ocel | Stahl | steel**  
Vinutí | Windung | finning  
32/92, 56/137, 76/156mm

 **Povrch | Oberfläche | surface**  
9010 RAL bílá | weiss | white  
+% ostatní | andere | other RAL

 **Parametry | Tech.Daten | data**  
max. 10 bar  
max. 120° C

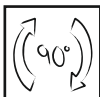
 **Vertikál | Vertikal | vertical**  
Spiralix Vertical  
na dotaz | auf Anfrage | on request

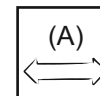
 **Délky | Längen | lengths**  
500 - 6000  
po | nach | each 100mm

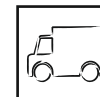

 **Dodání | Lieferung | Delivery**  
4 - 6 týdnů | Wochen | weeks

**LAURENS SPIRALIX tripple, RAO3 57/137**

na zem | Fussbonenvariante | floor version

**Indikace výkonu | Indikative Leistung | indicative output  $\Delta t$  50°C**  
**460 ~ 8240 Watt**  
(dle rozměrů radiátoru | je nach Abmessung | according size of radiator)

Všechny rozměry v MM | alle Abmessungen n MM | all dimensions in MM  
**L...délka otopného tělesa | Heizkörperlänge | length of radiator**  
**hladké trubky (bez vinutí) na dotaz | glatte Rohre (ohne Windung) auf Anfrage | tubes without winding on request**

-  Jen topení, (uzavřený) topný systém (voda nebo pára)  
Nur Heizung, (geschlossenes) Heizsystem (Wasser oder Dampf)  
Heating only, (closed) heating system (water or steam)
-  Kombinovaný provoz | Topení + elektrický  
Kombi-Betrieb | Wasser + Elektrisch  
Combined system | Water + electric heating
-  Jen elektrický provoz (na dotaz)  
Rein elektrisch (auf Anfrage)  
Electric version only (on request)

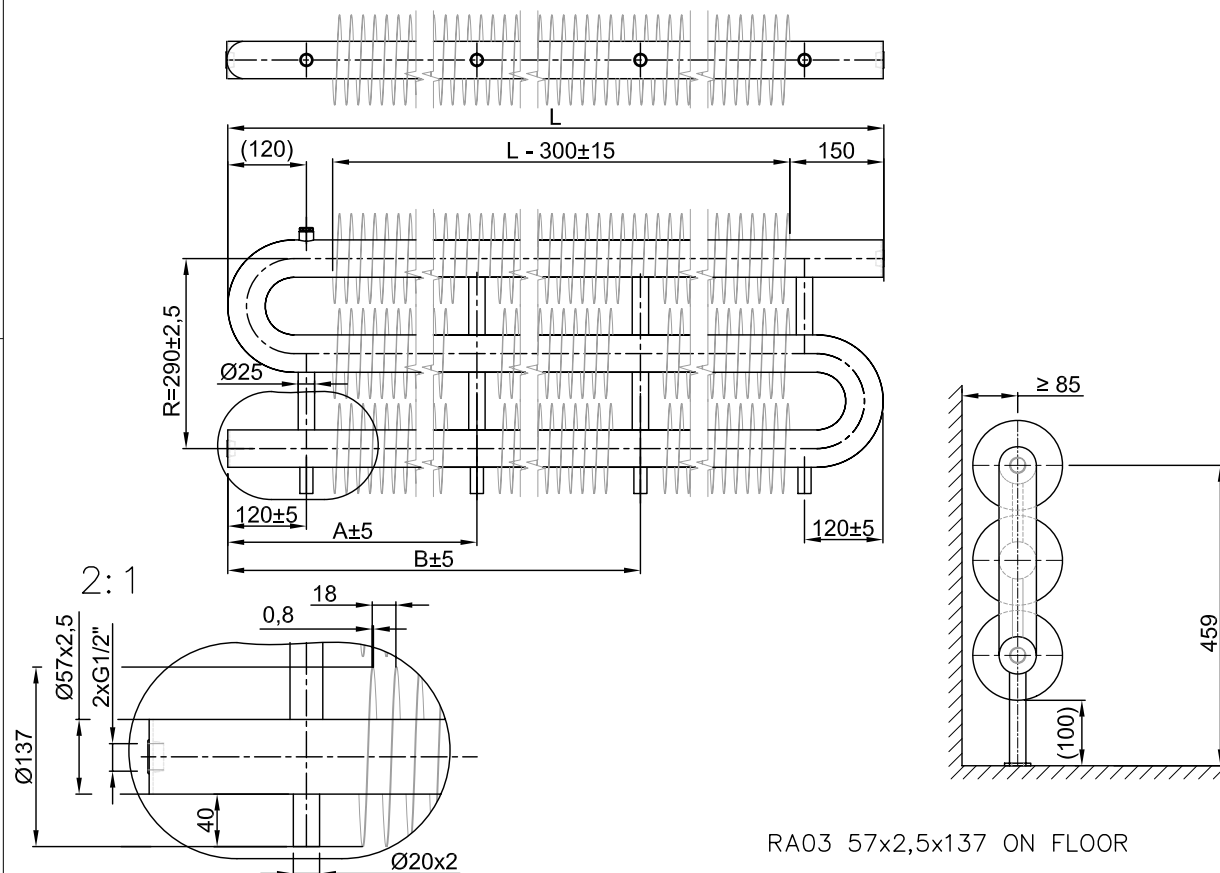
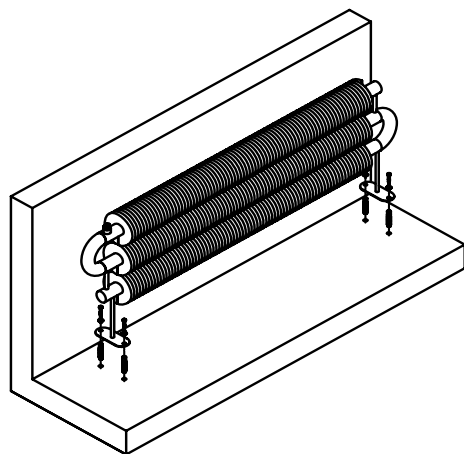

 **Ocel | Stahl | steel**  
Vinutí | Windung | finning  
32/92, 56/137, 76/156mm

 **Povrch | Oberfläche | surface**  
9010 RAL bílá | weiss | white  
+% ostatní | andere | other RAL

 **Parametry | Tech.Daten | data**  
max. 10 bar  
max. 120° C

 **Vertikál | Vertikal | vertical**  
Spiralix Vertical  
na dotaz | auf Anfrage | on request

 **Délky | Längen | lengths**  
500 - 6000  
po | nach | each 100mm

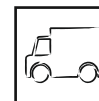

 **Dodání | Lieferung | Delivery**  
4 - 6 týdnů | Wochen | weeks

# LAURENS SPIRALIX tripple, RAO3 76/156

na stěnu | Wandvariante | wall-version

**Indikace výkonu | Indikative Leistung | indicative output  $\Delta t$  50°C**  
**470 ~ 8330 Watt**  
(dle rozměrů radiátoru | je nach Abmessung | according size of radiator)

Všechny rozměry v MM | alle Abmessungen n MM | all dimensions in MM  
**L...délka otopného tělesa | Heizkörperlänge | length of radiator**  
**hladké trubky (bez vinutí) na dotaz | glatte Rohre (ohne Windung) auf Anfrage | tubes without winding on request**

-  Jen topení, (uzavřený) topný systém (voda nebo pára)  
Nur Heizung, (geschlossenes) Heizsystem (Wasser oder Dampf)  
Heating only, (closed) heating system (water or steam)
-  Kombinovaný provoz | Topení + elektrický  
Kombi-Betrieb | Wasser + Elektrisch  
Combined system | Water + electric heating
-  Jen elektrický provoz (na dotaz)  
Rein elektrisch (auf Anfrage)  
Electric version only (on request)

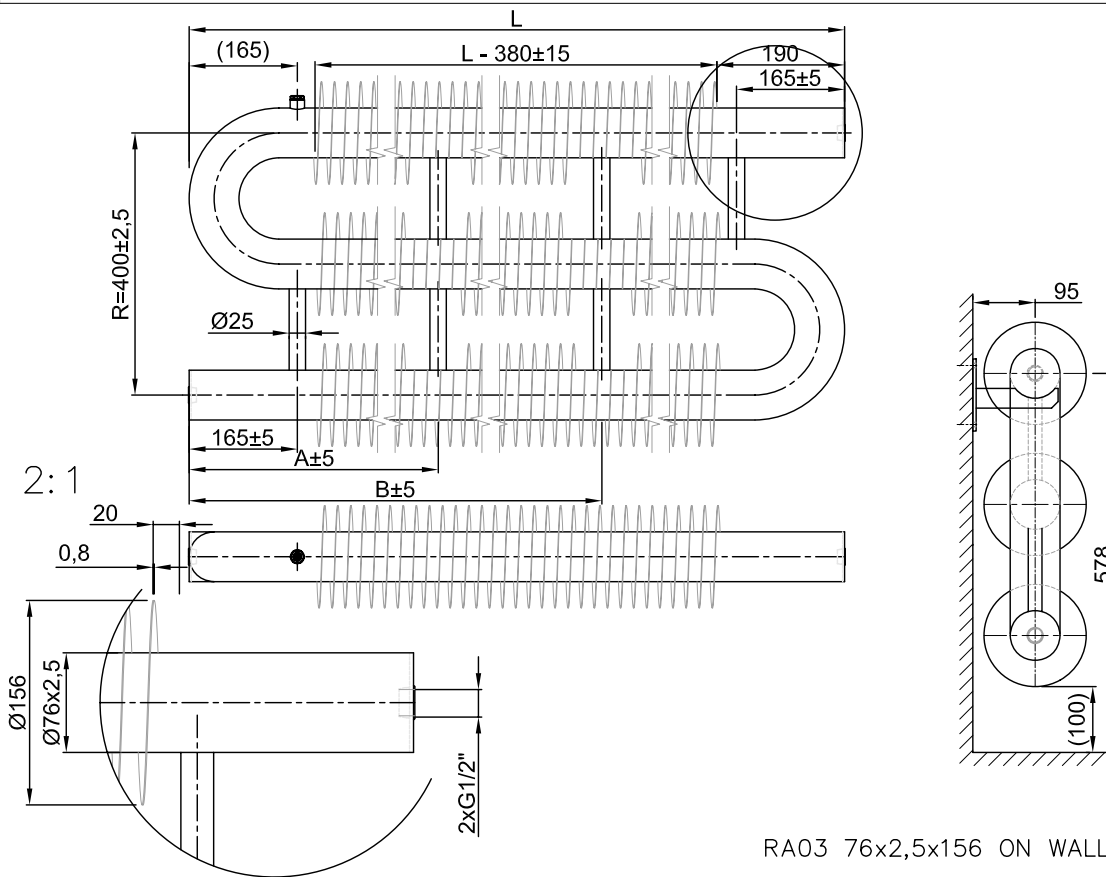
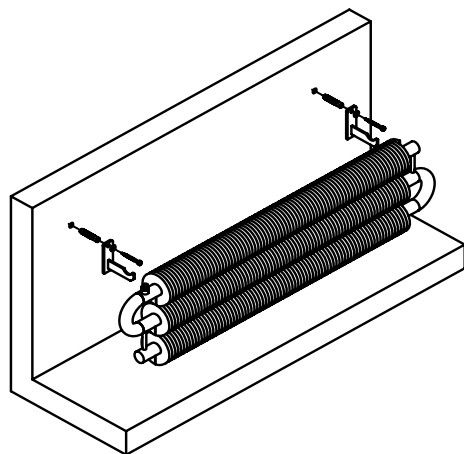



 **Ocel | Stahl | steel**  
Vinutí | Windung | finning  
32/92, 56/137, 76/156mm

 **Parametry | Tech.Daten | data**  
max. 10 bar  
max. 120° C

 **Délky | Längen | lengths**  
500 - 6000  
po | nach | each 100mm

 **Povrch | Oberfläche | surface**  
9010 RAL bílá | weiss | white  
+% ostatní | andere | other RAL

 **Vertikál | Vertikal | vertical**  
Spiralix Vertical  
na dotaz | auf Anfrage | on request



 **Dodání | Lieferung | Delivery**  
4 - 6 týdnů | Wochen | weeks

# LAURENS SPIRALIX tripple, RAO3 76/156

na zem | Fussbonenvariante | floor version

**Indikace výkonu | Indikative Leistung | indicative output  $\Delta t$  50°C**  
**470 ~ 8330 Watt**  
(dle rozměrů radiátoru | je nach Abmessung | according size of radiator)

Všechny rozměry v MM | alle Abmessungen in MM | all dimensions in MM  
**L...délka otopného tělesa | Heizkörperlänge | length of radiator**  
**hladké trubky (bez vinutí) na dotaz | glatte Rohre (ohne Windung) auf Anfrage | tubes without winding on request**

-  Jen topení, (uzavřený) topný systém (voda nebo pára)  
Nur Heizung, (geschlossenes) Heizsystem (Wasser oder Dampf)  
Heating only, (closed) heating system (water or steam)
-  Kombinovaný provoz | Topení + elektrický  
Kombi-Betrieb | Wasser + Elektrisch  
Combined system | Water + electric heating
-  Jen elektrický provoz (na dotaz)  
Rein elektrisch (auf Anfrage)  
Electric version only (on request)

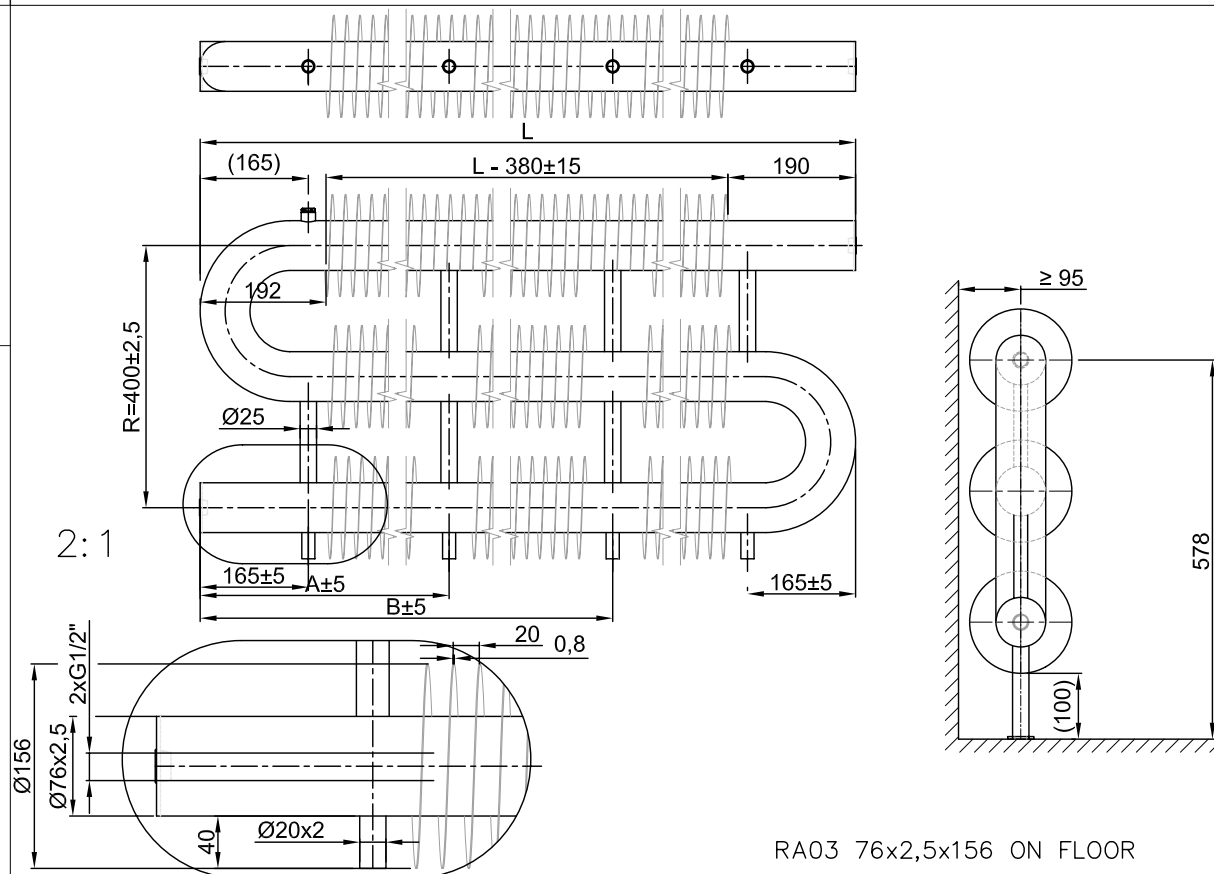
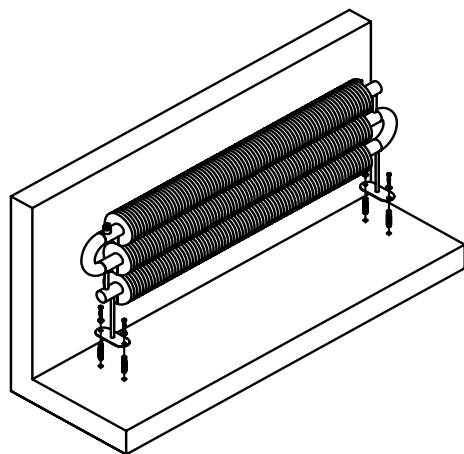

 **Ocel | Stahl | steel**  
Vinutí | Windung | finning  
32/92, 56/137, 76/156mm

 **Povrch | Oberfläche | surface**  
9010 RAL bílá | weiss | white  
+% ostatní | andere | other RAL

 **Parametry | Tech.Daten | data**  
max. 10 bar  
max. 120° C

 **Vertikál | Vertikal | vertical**  
Spiralix Vertical  
na dotaz | auf Anfrage | on request

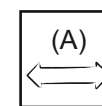
 **Délky | Längen | lengths**  
500 - 6000  
po | nach | each 100mm

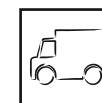
 **Dodání | Lieferung | Delivery**  
4 - 6 týdnů | Wochen | weeks